



**DANGER**



**THIS TOOL FOR USE BY LICENSED OPERATORS ONLY.  
READ AND OBEY ALL SAFETY AND OPERATING  
INSTRUCTIONS BEFORE OPERATING TOOL.**



**SA270 TOOL  
OPERATOR'S  
SAFETY & OPERATING  
INSTRUCTION MANUAL**



**SEMI-AUTOMATIC, LOW VELOCITY  
PISTON TYPE FASTENING TOOL**



**DANGER**



**THIS TOOL IS TO BE USED ONLY BY PROPERLY TRAINED AND LICENSED OPERATORS.**

**YOU MUST SUCCESSFULLY COMPLETE THE RAMSET TRAINING PROGRAM FOR THE TOOL AND OBTAIN A CERTIFIED OPERATOR'S LICENSE BEFORE HANDLING, LOADING OR OPERATING THIS TOOL.**

**ATTEMPTING TO HANDLE OR OPERATE THIS TOOL WITHOUT PROPER TRAINING AND LICENSING CAN RESULT IN SERIOUS INJURY TO THE OPERATOR OR BYSTANDERS.**

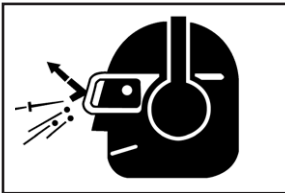

**Operator's and bystanders must wear eye and hearing protection.**

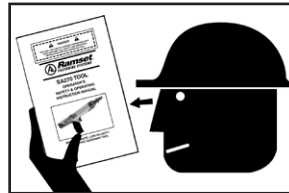

**Read manual before operating tool.**

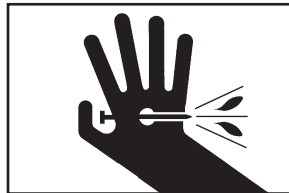
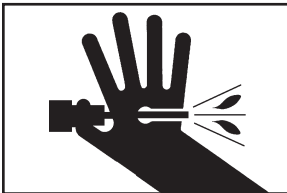

**Never close tool with hand over fastener loading end of the tool. A serious hand injury from penetration by the piston or a discharged fastener could result.**



**DANGER**



Just as no one can merely read a book about driving an automobile and then hope to drive one safely, no one should attempt to use any Ramset tool without adequate, competent personal instruction. And just as one must be licensed to drive an automobile, one must also be licensed to use a powder actuated tool. No automobile instruction book or instructor can forewarn a learner against all possibilities and emergencies, nor can Ramset instructors and printed material detail all possible conditions surrounding the use of Ramset tools and products.

**Responsibility for the safe and proper use of this tool rests with the tool user and the employer.**

## Preparation

### Acceptable Base Materials

Powder actuated fastening is suitable for use in the following base materials only:

- Poured Concrete
- Structural Steel
- Masonry Joints (see page 8)

Never attempt to fasten into any other type of material. Fastening into other materials can cause blindness or other serious injury.

### Unacceptable Base Materials

Never attempt to fasten into very hard or brittle materials such as cast iron, tile, glass, or rock of any type. These materials can shatter, causing the fastener and/or base material fragments to fly free and cause serious injury to the tool operator and others.

Never fasten into soft base materials, such as drywall or lumber products. These materials may allow the fastener to travel completely through and out the other side, endangering those in the path of the fastener.

Never fasten into any base material that does not pass the Center Punch test. Failure to assure the suitability of the base material can result in serious injury to the eyes or other body parts.

## Center Punch Test

**ALWAYS WEAR SAFETY GOGGLES WHEN PERFORMING THIS TEST.**

1. Always check the material being fastened into for hardness before attempting any fastening operation.
2. Using a fastener as a center punch, strike the fastener against the work surface using an average hammer blow and check the results.

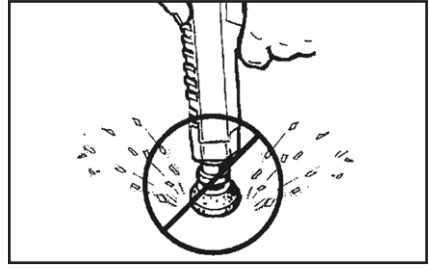

**NEVER FASTEN INTO VERY HARD OR BRITTLE MATERIALS**

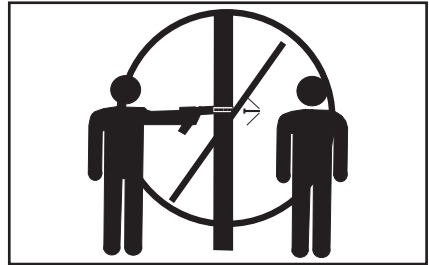

**NEVER FASTEN INTO SOFT MATERIALS SUCH AS DRYWALL**

## Center Punch Test Results

1. If the fastener point is flattened, the material is too hard for a powder actuated fastening.
2. If the fastener penetrates the material easily, the material is too soft.
3. If the material cracks or shatters, the material is too brittle.
4. If the fastener makes a small indentation into the material, the material is suitable for fastening.

**Loads & Load Selection Safety**

1. Always make a test fastening after being sure that the base material is suitable for powder actuated fastening. Failure to determine the correct power level to be used may result in the use of excessive power, allowing the fastener to pass completely through the work material, causing serious or fatal injuries to others who may be in the path of the fastener.
2. Color-blind operators must always select loads by number to prevent use of an incorrect load for the same reasons as in #1 above.

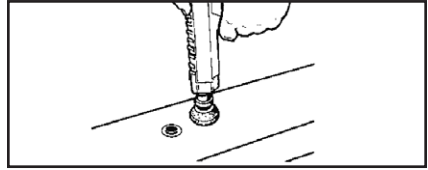

**ALWAYS MAKE A TEST FASTENING**

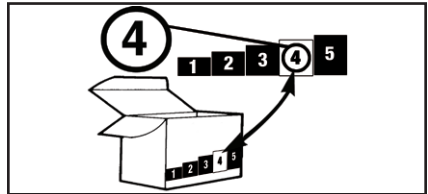

**COLOR-BLIND OPERATORS MUST ALWAYS SELECT LOADS BY NUMBER**

**Workplace Safety**

1. Operators and bystanders must always wear approved eye protection and approved hearing protection. Failure to do so may result in blindness or serious eye injury from flying debris and loss of hearing from constant or repeated unprotected exposure to fastening noise.
2. Always keep the work area clear of bystanders and unnecessary materials that could interfere with safe tool operation. Operating the tool in a congested or cluttered area may affect your ability to operate the tool safely.
3. Never operate tool if flammable or explosive materials are nearby. Powder loads burn and create sparks when fired and could ignite these materials or fumes.
4. Always post warning signs within 50 ft. of the area where fastening is to be done. Sign must state: "WARNING - Powder Actuated Tool In Use". Failure to warn others may result in serious injury to them. Contact Ramset at 1-800-241-5640 to obtain this sign.



**KEEP WORK AREA CLEAR OF BYSTANDERS AND CLUTTER**



**NEVER OPERATE THE TOOL AROUND FLAMMABLE OR EXPLOSIVE MATERIALS**



**ALWAYS POST WARNING SIGNS**

**Tool Handling Safety**

1. Always be sure tool is operating properly before attempting to use it. Follow the “Daily Function Check” shown to the right and described on page 9.
2. Always load tool using a strip load selected directly from a box indicating the power load type and number. Never attempt to use loose strip loads that could be mis-identified.
3. Never carry loose loads in pockets with pins or other hard objects.
4. Never load a tool unless you intend to immediately make a fastening. *Loading a tool and leaving it unattended in the work area can result in the tool being accidentally discharged by others.*
5. Never place your hand or any other body part over the fastener loading end of the tool. *Serious hand injury could result from being struck by either a fastener or the tool piston should the tool be accidentally fired.*
6. Always store the tool unloaded and keep the tool and the loads securely locked in a tool box. Keep keys away from children and unlicensed persons.
7. Always keep the tool pointed away from yourself and others.
8. Never carry a loaded tool around the work area.
9. Never allow anyone not trained to use the tool.
10. Never engage in horseplay with the tool.
11. Using the tool in poorly ventilated areas, cleaning tool or handling loads may result in exposure to lead or other substances known to cause birth defects, and other physical harm. Have adequate ventilation at all times and wash thoroughly after exposure.

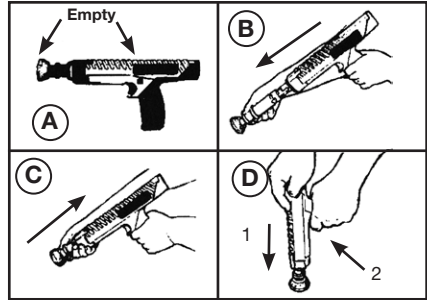

**ALWAYS DO A DAILY FUNCTION CHECK BEFORE LOADING TOOL**

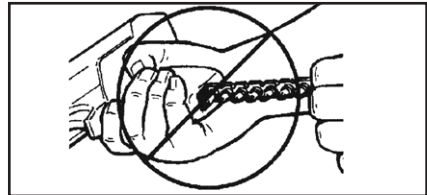

**NEVER LOAD THE TOOL UNLESS IT IS TO BE USED IMMEDIATELY**

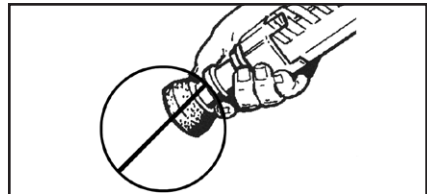

**NEVER PLACE HANDS OR BODY OVER MUZZLE OPENING**

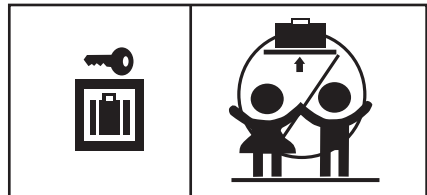

**KEEP TOOL LOCKED & OUT OF THE REACH OF CHILDREN**

**FAILURE TO FOLLOW INSTRUCTIONS CAN CAUSE INJURY TO THE TOOL OPERATOR OR TO BYSTANDERS.**

**Fastener Driving Safety**

1. Only use the tool for fastening into a suitable base material.
2. Never fire the tool without a fastener. *Firing a tool without a fastener will cause the piston to strike the work surface, and may cause serious injury to you and others in the work area.*
3. Always use the spall guard whenever possible to minimize flying particles or debris.
4. Always hold the tool perpendicular to and firmly against the work surface when making a fastening. *Failure to do so could allow a fastener to ricochet.*
5. Never attempt to drive a fastener close to an edge or to another fastener. See page 8 for guidelines.

**ALWAYS FOLLOW THE MISFIRE PROCEDURE.**

If the tool does not fire after the normal firing sequence, continue to hold the depressed tool against the work surface for at least 30 seconds. Then carefully lower the tool, remove the strip load, and put it in a can of water or other non-flammable liquid. Never carelessly discard a strip with live loads into a trash container.

If the tool becomes stuck or jammed with a live powder load, keep the tool pointed in a safe direction, and immediately tag it, "Danger- defective - do not use". Lock the tool in a tool box and call your local Ramset distributor for assistance.

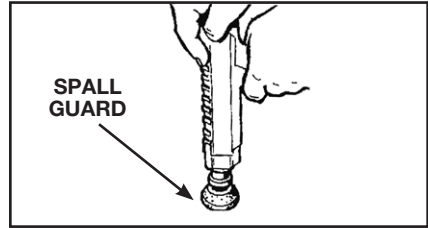

**USE SPALL GUARD WHENEVER POSSIBLE**

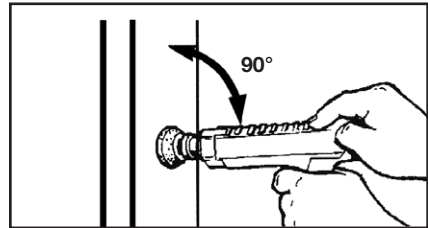

**ALWAYS HOLD THE TOOL PERPENDICULAR TO THE WORK SURFACE**

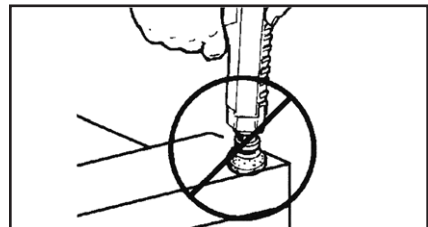

**NEVER DRIVE A FASTENER CLOSE TO AN EDGE**

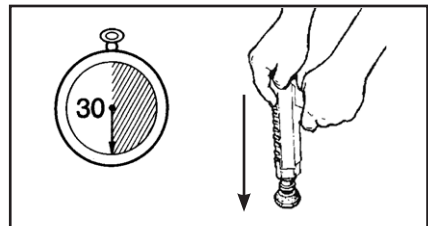

**HOLD THE TOOL FIRMLY AGAINST THE WORK SURFACE FOR AT LEAST 30 SECONDS**

# FASTENERS / LOADS

Your Ramset SA270 Tool uses only the Ramset fasteners and loads shown below or listed for the tool in the Product Catalog.



**DANGER**



Never use any other types of fasteners or strip loads in the Ramset SA270 Tool. Use of other types of fasteners or loads may cause unintentional load discharge, damage the tool, cause poor fastening performance, or create a risk of serious injury to the operator or bystanders.

## FASTENERS

**.300 HEAD PLASTIC FLUTED DRIVE PINS**

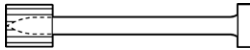

.145 Shank Diameter in Shank Lengths from 1/2" to 2-1/2"

**.300 HEAD PLASTIC FLUTED DRIVE PINS WITH 7/8" WASHER**

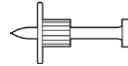

.145 Shank Diameter in Shank Lengths from 1" to 3"

**1/4" - 20 THREADED STUDS**



.145 Shank Diameter in Shank Lengths of 1/2" and 1" and Thread Lengths of 1/2", 3/4" and 1"

**.300 HEAD POWER POINT PLASTIC FLUTED DRIVE PINS**

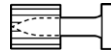

.150 Straight Shank in Shank Lengths from 1/2" to 7/8"  
.150/.180 Step Shank in Lengths from 1" to 1-7/8"

**8 mm HEAD TOP-HAT DRIVE PINS**



.145 Shank Diameter in Shank Lengths from 1/2" to 1"

**CEILING CLIP ASSEMBLIES**



**CONDUIT CLIP ASSEMBLIES**



For 1/2" and 3/4" Diameter Conduit with 1" Premounted Fastener

Ceiling Clip with 1" or 1-1/4" premounted .145 Shank Pin and Ceiling Clip with 1" or 1-1/4" Premounted .150/.180 Shank Pin

## LOADS

Ramset RS27 strip loads are specially made for use in the Ramset SA270 Tool.



**RS27 10 SHOT STRIP LOAD**

The power level of the load is indicated by the number marked on each box, the color of the box, and the color on the tip of each load. As the number increases, the power level also increases.

Always perform the center punch test described on page 3 to test the base material.

Always make a test fastening using the lowest power level first. If more power is required to set the fastener, use the next higher power level until the powder level necessary to drive the fastener is reached.

POWER LEVEL	CATALOG NUMBER	LOAD COLOR	CASE COLOR
2	2RS27	Brown	Brass
3	3RS27	Green	Brass
4	4RS27	Yellow	Brass
5	5RS27	Red	Brass

# FASTENERS / LOADS

# FASTENING APPLICATIONS

---

## FASTENING APPLICATIONS

Your Ramset tool can be used for a wide range of fastening needs in a variety of base materials. Reading and follow these important fastening guidelines will help you get the best results from your tool, fasteners, and powder loads, as well as help you perform these fastening operations safely and effectively.

Powder actuated fastenings are permanent fastening so attempting to remove a fastener from concrete or steel may result in serious injury.

### Fastening to Concrete

When fastening into concrete, always maintain a minimum spacing of 3" between fastenings and 3" from any free edge. Concrete thickness should be at least three times the intended penetration depth into the concrete. The primary exception to the 3" edge distance can occur in a sill plate application where, by necessity, the edge distance is reduced.

Driving fasteners too close to an edge or too close to each other can cause the concrete edge to fail or fasteners to fly free.

### Fastening to Concrete Block or to Masonry Walls

While this application is not recommended, when used, it is necessary to take care to observe a 3" edge distance to avoid cracking the block and over penetration of the fastener to avoid loss of holding value. Fastening may be made into the horizontal joint but not into the vertical joint.

### Fastening to Steel

Your Ramset tool can be used for fastening on the flat surfaces of structural steel. When fastening into steel, always maintain a minimum spacing of 1-1/2" between fastenings and 1/2" from any edge.

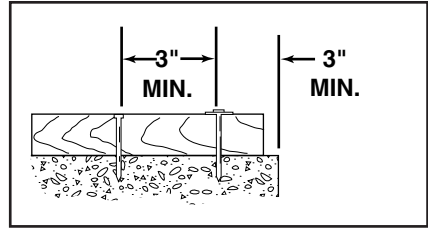

SPACING WOOD TO CONCRETE

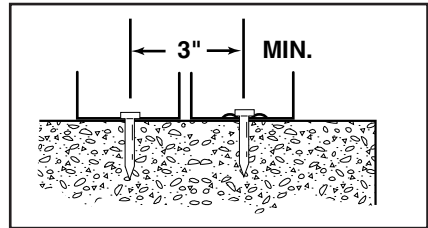

PENETRATION — THIN GAUGE METAL TO CONCRETE

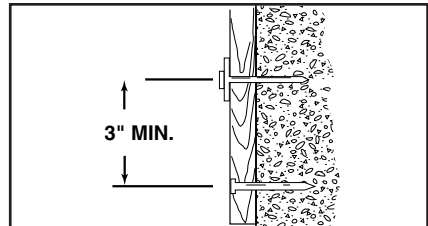

SPACING — FURRING STRIP TO CONCRETE

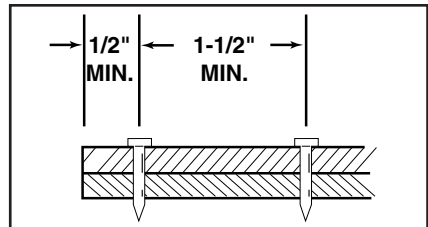

SPACING — STEEL TO STEEL

---

# FASTENING APPLICATIONS



---

## TOOL OPERATING INSTRUCTIONS

### TOOL OPERATION

#### Daily Function Test

**Always check the tool first to make sure that it does not contain a strip load or fastener.** Test the tool several times by depressing the muzzle bushing fully on a hard surface and pulling the trigger. You should hear an audible click as the firing pin releases. Let up on the tool and check to be sure that the barrel has opened to the semi-open position.

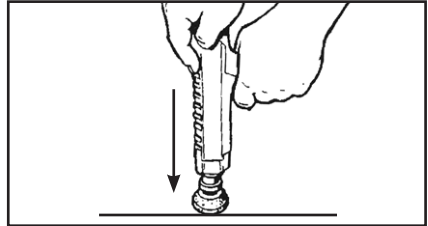

PERFORM THE FUNCTION TEST WITH EMPTY, UNLOADED TOOL

### OPERATING THE RAMSET SA270 TOOL

1. After checking to be sure that the tool is not loaded, point it in a safe direction and be sure that the barrel is fully extended and then close the tool to the semi-closed position. This assures that the piston is in position for the next fastening. Use the spall guard every time possible to minimize the risk of being struck by flying debris.
2. With finger off the trigger, place the fastener, point out, into the muzzle end of the tool until the point end is inside the muzzle. **NEVER** load a fastener with your finger on the trigger. **DO NOT** use excessive force when inserting a fastener. **STOP** immediately if excessive force is require, inspect the barrel to find out why the fastener is not entering the muzzle freely. **DO NOT** continue loading unless the problem is corrected.
3. With the tool pointed in a safe direction and finger away from the trigger, insert a load strip into the bottom of the handle and push it in until your finger is in firm contact with the handle recess.

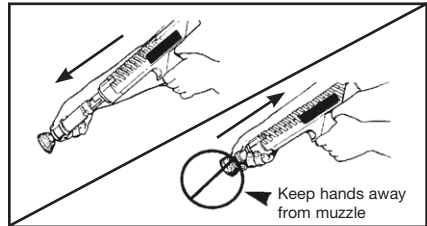

FULLY OPEN AND CLOSE TOOL TO THE SEMI-CLOSED POSITION

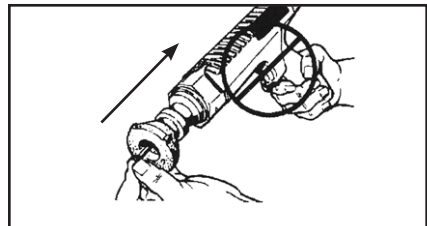

INSERT FASTENER INTO THE MUZZLE END OF THE TOOL WITH THE POINT OUT

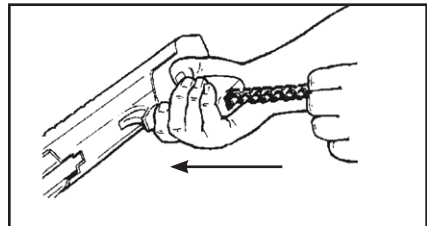

INSERT LOAD STRIP INTO THE OPENING IN THE BOTTOM OF THE HANDLE

# TOOL OPERATING INSTRUCTIONS

4. Hold the tool perpendicular (90°) to the work surface with both hands and press firmly to fully depress the tool. Maintain firm downward pressure on the tool with both hands and pull the trigger to drive the fastener. **DO NOT DEPRESS THE TOOL AGAINST ANYTHING OTHER THAN THE INTENDED WORK SURFACE.** Holding the tool firmly in place will produce more consistent fastening quality and minimize tool wear or damage.
5. After making the fastening, fully open and then close the tool to the semi-closed position. This resets the piston and indexes a new load into place for the next fastening.
6. Insert another fastener in the muzzle end of the tool as before and the tool is ready for the next fastening. Keep your finger off of the trigger until the tool is in position to drive the fastener.
7. To remove a used or partially used strip load from the tool, pull the strip out from the top of the tool. Do not try to remove the strip by pulling it out from the bottom of the handle. **NEVER** try to remove a jammed or stuck load strip. Should a “jammed” load strip occur, call your local Authorized Ramset Distributor for technical assistance.

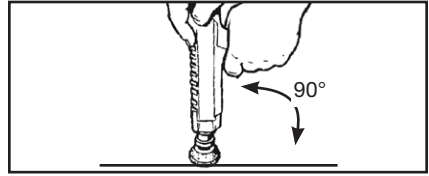

**HOLD THE TOOL FIRMLY AND PERPENDICULAR TO THE WORK SURFACE**

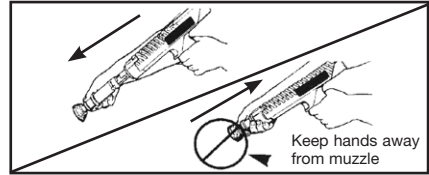

**FULLY OPEN AND CLOSE TOOL TO THE SEMI-CLOSED POSITION**

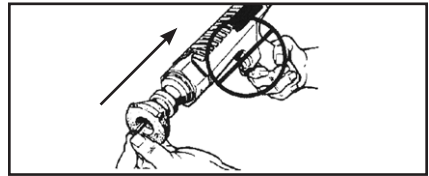

**INSERT THE NEXT FASTENER**

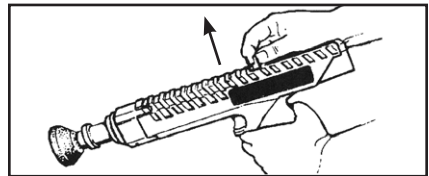

**REMOVE THE LOAD STRIP ONLY FROM THE TOP OF THE TOOL**

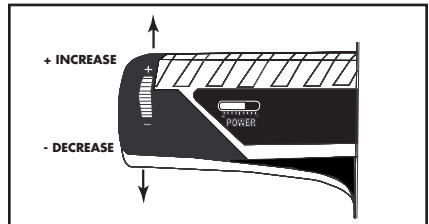

**POWER LEVEL ADJUSTMENT**

## Power Adjust

The power level on the SA270 may be adjusted for varying base materials by turning the power adjust wheel located at the rear of the tool.

# TOOL OPERATING INSTRUCTIONS

## TROUBLESHOOTING

### REFER TO PARTS SCHEMATIC FOR PROPER ASSEMBLY OF PARTS

- Overdriving of fasteners	- Excessive power	- Change to the next lower power level load strip color and number.
	- Soft base material	- Check base material (see page 3)
- Tool fails to fire	- Failure to depress completely	- See "Tool does not completely depress"
	- Excessive dirt buildup on breech face not allowing proper penetration of firing pin	- After following misfire procedure, check firing pin indentation on load. Clean breech face
	- Firing pin and/or breech damaged	- Replace damaged parts
- Tool does not completely depress	- Misassembled or damaged parts	- Check all parts in the receiver for damage or improper assembly.
- Reduction or loss of power	- Power adjust dial turned down	- Adjust power dial
	- Piston not being returned to the full rear position	- Barrel must be pulled completely open to properly position the piston.
	- Worn or damaged piston or piston ring	- Replace worn or damaged parts
	- Worn or broken pawls	- Replace pawls
- Tool cannot be cocked or opened	- Excessive dirt buildup	- Clean tool thoroughly
	- Damaged or bent piston	- Replace piston
	- Broken or damaged parts	- Tag tool with warning "Defective-Do Not Use" Place in a locked container and contact your local Ramset representative for service.
- Failure to index strip	- Strip not inserted in tool correctly or is damaged	- Check load strip. Properly dispose of damaged strip. (See page 6)
	- Damaged indexing mechanism	- Contact your Ramset Distributor for assistance
- Failure of tool to stay closed when pointed in the downward position	- Retaining ball missing	- Contact your Ramset Distributor for assistance

**PARTS SCHEMATIC**

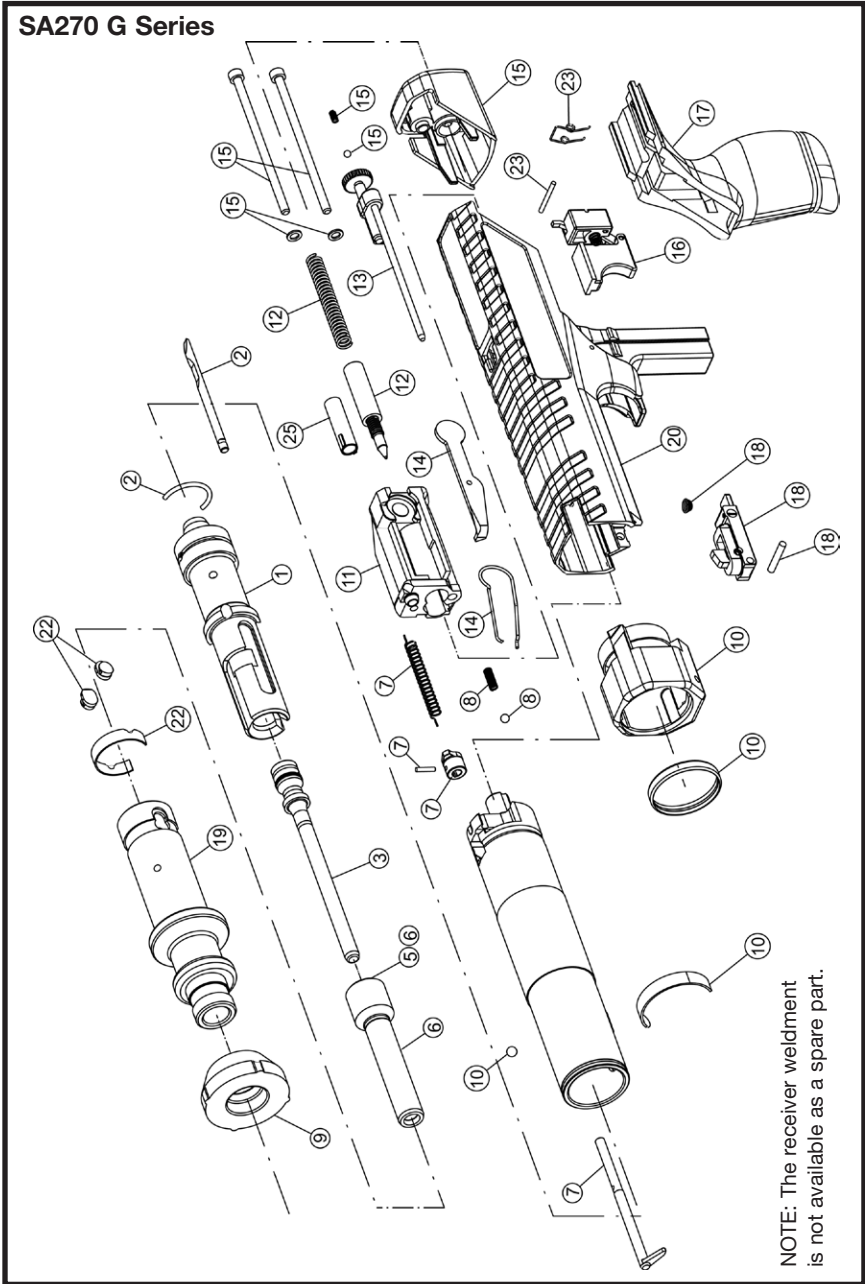

---

## PARTS LIST / MAINTENANCE

### SA270 (G-SERIES) PARTS LIST

---

KEY	PART NO.	DESCRIPTION
1	28266	REAR BARREL ASSEMBLY
2	27563A	LOAD ADVANCE ROD ASSEMBLY
3	27833	PISTON WITH RING
5	27834	BUFFER
6	27831	MUZZLE BUSHING ASSEMBLY
7	28310	ROTARY SEAR & COCKING ROD KIT
8	27524A	STRIP DETENT BALL AND SPRING
9	27580	SPALL GUARD
10	27888	FRONT HOUSING KIT
11	28090	MECHANISM HOUSING
12	28157	FIRING PIN KIT
13	28178	POWER ADJUSTMENT KIT
14	27527A	ADVANCE LEVER KIT
15	28135	END CAP KIT
16	27608	TRIGGER KIT
17	28170	RUBBER HANDLE
18	27923	RETRACTOR KIT
19	27664	FRONT BARREL
20	28277	OUTER HOUSING
22	27882	FRONT BARREL RETAINER KIT
23	27516A	TRIGGER PIN & SPRING
25	A1095	MECHANISM HOUSING PLUG

\* The receiver weldment is not available as a spare part

---

## MAINTENANCE

<p style="text-align: center;"><b>IMPROPERLY MAINTAINED TOOLS CAN CAUSE SERIOUS INJURIES TO TOOL OPERATOR AND BYSTANDERS CLEAN TOOL DAILY</b></p>
---

Always make sure the tool is not loaded before performing any service or repair and always wear safety goggles when cleaning or servicing the tool.

### **NORMAL CLEANING**

All front end parts shown in the disassembly section are to be cleaned daily with a good detergent oil and wire brush. Remove all dirt and carbon buildup and wipe parts dry with a clean rag. Check all parts for wear or damage before reassembly and replace or repair any worn or damaged parts.

### **COMPLETE CLEANING / GENERAL MAINTENANCE**

Heavy or constant exposure to dirt and debris may require that the tool be cleaned more extensively. Complete disassembly and cleaning of all parts may be necessary to restore the tool to normal operation. General maintenance should be performed every six months or more often if the tool is subjected to heavy use. Contact your authorized Ramset Distributor for assistance.

<p style="text-align: center;"><b>ALWAYS FUNCTION TEST THE TOOL AFTER PERFORMING ANY SERVICE. SEE PAGE 9 FOR DETAILS ON THE FUNCTION TEST.</b></p>
--

---

## PARTS LIST / MAINTENANCE

# DISASSEMBLY

---

## TOOL DISASSEMBLY

1. Depress the detent pin to release the pawl.

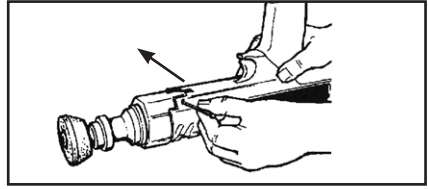

**DEPRESS DETENT PIN TO RELEASE THE PAWL**

2. Lift the pawl up to release the barrel assembly. Check the O-ring around the pawl housing for damage and replace as necessary.

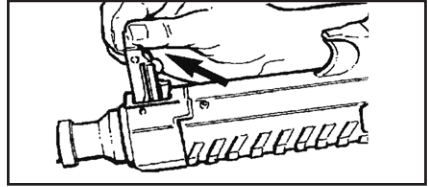

**PIVOT PAWL UPWARD**

3. Slide the barrel assembly out of the tool body while holding the pawl in the open position.

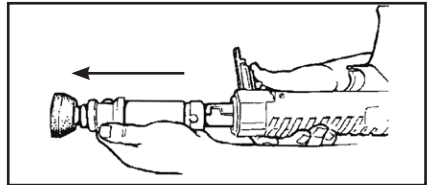

**REMOVE THE BARREL ASSEMBLY**

4. Slide the front barrel back until the round shear pin is in line with the perpendicular slot in the rear barrel.

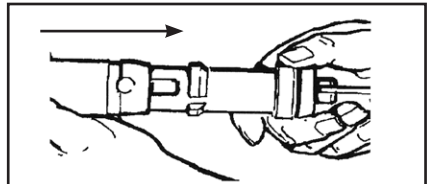

**ALIGN SHEAR PIN WITH SLOT**

5. Twist the front barrel in the slot and rotate it 90°.

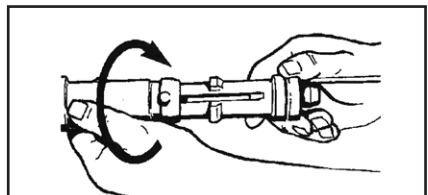

**TWIST BARREL IN SLOT AND ROTATE 90°**

---

# DISASSEMBLY

6. Slide the front barrel from the rear barrel and remove the piston from the rear barrel.

**The tool is now disassembled for normal cleaning.** Inspect all parts for wear or damage and clean or replace as required. Use detergent oil and cleaning brushes to remove dirt and powder residues. Wipe all parts dry before reassembly. **Wear safety goggles when cleaning tool parts.**

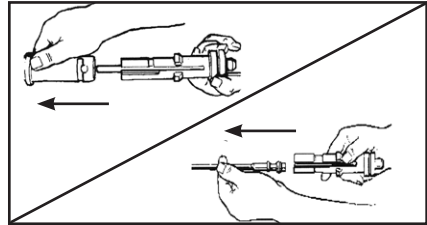

**REMOVE THE PISTON AND FASTENER GUIDE**

7. Check the piston tip for damage and grind flat. The tip of the piston must be  $90^\circ$  to the shank. Grinding should only be done by qualified personnel. The minimum overall length of the piston must not be less than 5.9" long. When less than 5.9" long, the piston must be replaced to avoid tool damage.

Reassemble the tool in the reverse order of disassembly.

Normal front end cleaning may be done without disassembling the rear barrel. If it is necessary to disassemble the rear barrel for part replacement, use a drive pin or small, flat screwdriver to pry the retaining clip out of the groove in the rear barrel to release the load advance rod. When removing the advance rod, note the position of the notch in the rod since the notch must be aligned with the retaining clip groove for reassembly.

**ALWAYS PERFORM THE DAILY FUNCTION TEST BEFORE USING THE TOOL AFTER CLEANING OR SERVICING.**

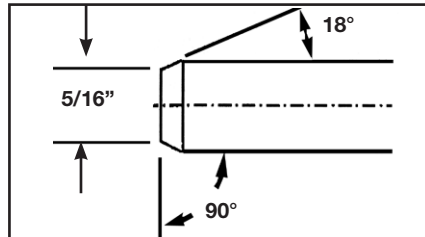

**GRIND THE PISTON TIP FLAT AND BEVEL THE EDGE**

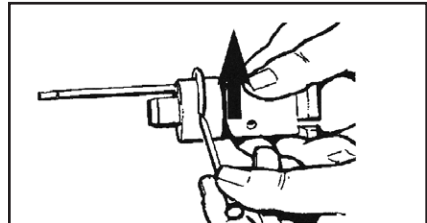

**ALIGN THE FRONT AND REAR BARREL GROOVES**

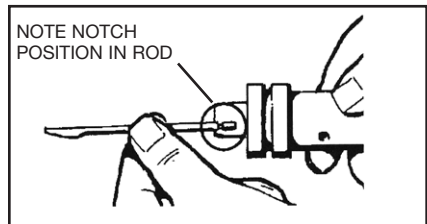

**ALIGN THE BARREL ASSEMBLY GROOVE WITH THE PAWL OPENING**

# SA270 WARRANTY AND LIMITATIONS

Ramset warrants that new SA270 power fastening tools, parts and accessories will be free from defects in material and workmanship for the period shown below.

### THREE-YEAR WARRANTY

A three-year warranty will apply to all parts, except those listed below as normal wearing parts, or parts which are specifically covered by an extended warranty.

The following parts are considered normal wearing parts and are excluded from the warranty:

- Piston
- Buffer
- Spring Clips
- Pawls
- Piston Rings

The warranty period is based off of tool build date, determined from the tool serial number. Ramset may extend the warranty time frame from the date of purchase with a qualifying document proving date of purchase.

### WARRANTY STATEMENT

Ramset's sole liability hereunder will be to replace any part or accessory which proves to be defective within the specific time period. Any replacement part or accessory provided in accordance with this warranty will carry a warranty for the balance of the period of warranty applicable to the part it replaces. This warranty does not apply to part replacement required due to normal wear.

This warranty is void as to any tool which has been subjected to misuse, abuse, accidental or intentional damage, use with fasteners, and loads not meeting Ramset specification, size, or quality, improperly maintained, repaired with other than genuine SA270 replacement parts, damaged in transit or handling, or which, in Ramset's opinion, has been altered or repaired in a way that affects or detracts from the performance of the tool.

Ramset MAKES NO WARRANTY, EXPRESSED OR IMPLIED, RELATING TO MERCHANTABILITY, FITNESS, OR OTHERWISE, EXCEPT AS STATED ABOVE and the liability AS STATED ABOVE AND AS ASSUMED ABOVE is in lieu of all other warranties arising out of, or in connection with, the use and performance of the tool, except to the extent otherwise provided by applicable law.

Ramset SHALL IN NO EVENT BE LIABLE FOR ANY DIRECT, INDIRECT, OR CONSEQUENTIAL DAMAGES, INCLUDING, BUT NOT LIMITED TO DAMAGES WHICH MAY ARISE FROM LOSS OF ANTICIPATED PROFITS OR PRODUCTION, SPOILAGE OF MATERIALS, INCREASED COST OF OPERATION OR OTHERWISE.

Ramset reserves the right to change specifications, equipment, or designs at any time without notice and without incurring obligation.

Copyright 2008 Ramset



**THE MODEL SA270 TOOL COMPLIES WITH OSHA REQUIREMENTS AND WITH ANSI A10.3 SPECIFICATIONS**

**FOR TOOL REPAIR SERVICE CONTACT YOUR LOCAL AUTHORIZED RAMSET DISTRIBUTOR OR TO FIND YOUR NEAREST RAMSET TOOL REPAIR CENTER VISIT OUR WEB SITE AT [WWW.RAMSET.COM](http://WWW.RAMSET.COM) OR CALL 800-241-5640**



**Concrete Fastening Systems  
Glendale Heights, IL 60139  
800-RAMSET6 (1-800-726-7386)  
[www.ramset.com](http://www.ramset.com)**

**Buy with Confidence...  
Buy From Your Authorized Distributor**

**AN ILLINOIS TOOL WORKS COMPANY  
© ILLINOIS TOOL WORKS 2008**